

FX-SMX44

4x4 Seamless HDMI Matrix With 2x2 Video Wall Controller

Dear Customer

Thank you for purchasing this product. For optimum performance and safety, please read these instructions carefully before connecting, operating or adjusting this product. Please keep this manual for future reference.

ABLE OF CONTENTS

Feature

Specifications

Package Contents

Panel Descriptions

Connecting and Operating

Typical Application

Product Service

Warranty

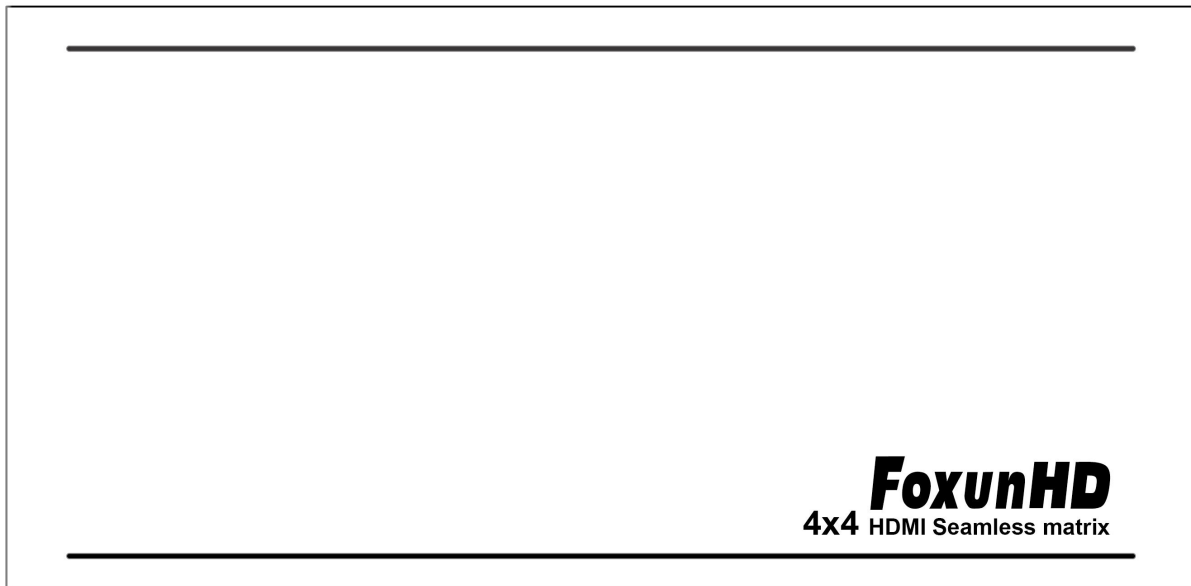

Feature

- Any one of the 4 sources to any one of the 4 displays
- Seamless switching ensures no switching delay and picture loss during Transitions, the switching speed is less than 1 second
- Support 2x2 Video wall mode
- Any one of the four outputs can be turned off independently
- Each port support both HDMI and DVI inputs
- Support high definition resolutions, including: 1080p@60Hz@36b/pixels, 1080i, 720p and other standard video formats
- With panel button, Remote Control, RS232 Control, IP Control to select the source
- 1U rack design, easy installment
- DC 12V 3A power supply
- Size: L438xW220xH44mm
- Weight: 2.80kg

NOTICE

Our company reserves the right to make changes in the hardware, packaging and any accompanying documentation without prior written notice.

SPECIFICATIONS

Operating Temperature Range	-5 to +65°C (+23 to +149°F)
Operating Humidity Range	5 to 90 % RH (no condensation)
Input Video signal	0.5-1.0 volts P-P
Input DDC Signal	5 volts p-p(TTL)
Video Format supported	DTV/HDTV:1080P/1080i/720P/576P/480P/576i/
Audio Format supported	LPCM
Input ports	4xHDMI(standard Type A connector)
Output ports	4xHDMI(standard Type A connector)
Matrix mode	4x4 Seamless switching
Video wall mode	2x2 video wall
Power Consumption	24watts
Dimensions(LxWxH)	438×220×44mm
Mass (Main Unit)	2800g

Note: Specifications are subject to change without notice. Mass and dimensions are approximate.

PACKING CONTENTS

- 1) 4x4 Matrix (FX-SMX44) 1pcs
- 2) Remote controller 1pcs
- 3) CD ROM (user manual) 1pcs
- 4) Power adapter 12V3A 1pcs
- 5) Mountain ears 1pair
- 6) IR cable 1pcs
- 7) Operating Instructions.

Notes: Please confirm if the product and the accessories and all in duded, if not please contact with the dealers.

PANEL DESCRIPTION

Front Panel

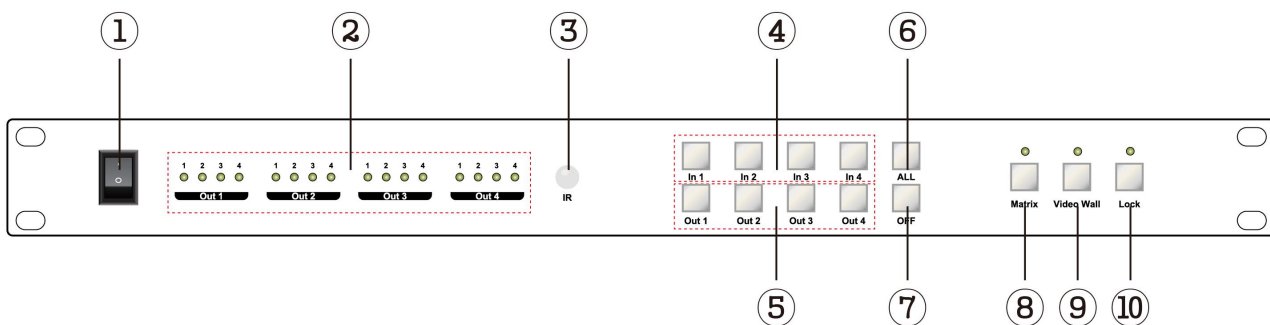

- 1) Power on/off

- 2) These LED indicates the status of each output selection
- 3) IR receive window
- 4) Input button IN 1-4:choose the desired input port from ports 1~4
- 5) Output button OUT1~4:choose the desired output port from ports 1~4
- 6) ALL:Press this button to set all the outputs to display with the same input,First press the “ALL” button then press an input number to confirm the selection
- 7) OFF button: first press “OFF”, then press the corresponding output number or “ALL” to turn off and turn on the video output
- 8) Matrix mode key and led:the machine will work in matrix mode
- 9) Video Wall mode key and led:the machine will work in video wall mode
- 10) Lock button: lock and unlock the function of all the keys, the led will turn red when lock enabled

Rear panel

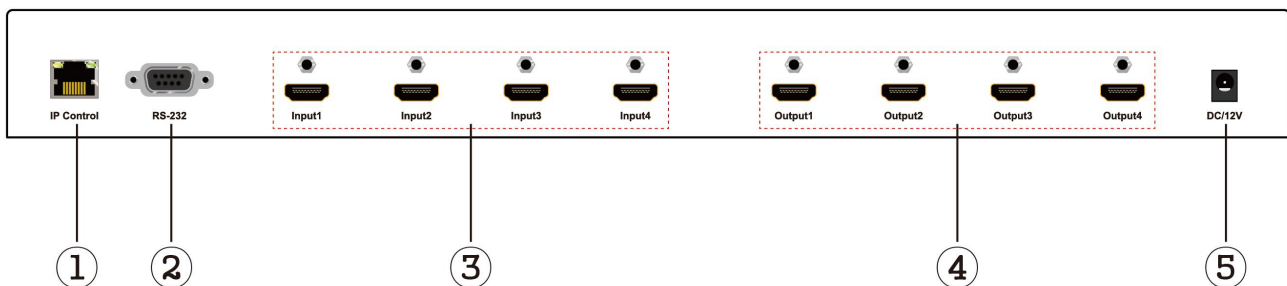

- 1) LAN port
- 2) RS232 port
- 3) HDMI input port
- 4) HDMI output port
- 5) Power input:12V 3A

CONNECT AND OPERATE

- 1) Connect source devices to input ports of FX-SMX44.
- 2) Connect HDMI output port to TV or other HDMI sink devices.
- 3) Optional: Connect RS232 cable from PC RS232 port
- 4) Optional:Connect an Ethernet cable from the TCP/IP port on the matrix to a local area Network.
- 5) Connect 12V/3A power supply to DC power socket.
- 6) Power on the FX-SMX44, HDMI sources and displays.

Application1

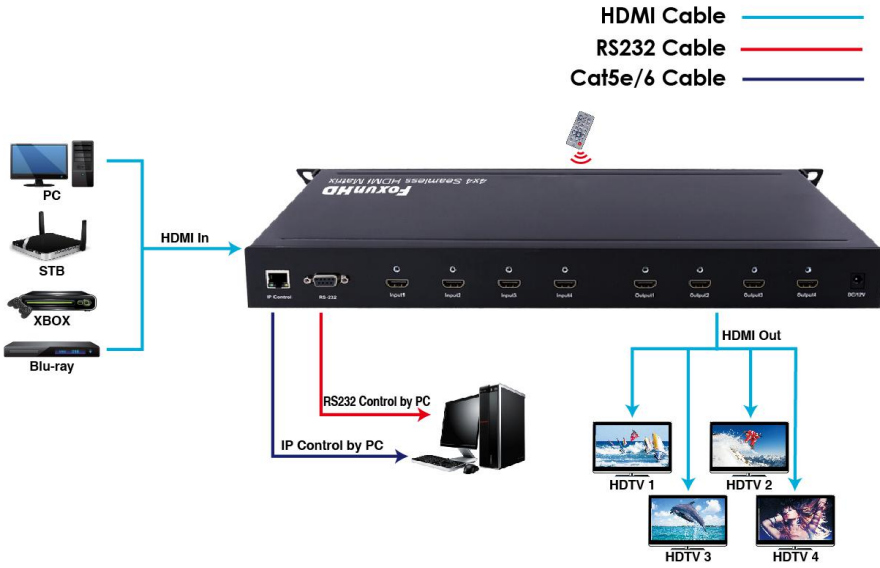

Application 2

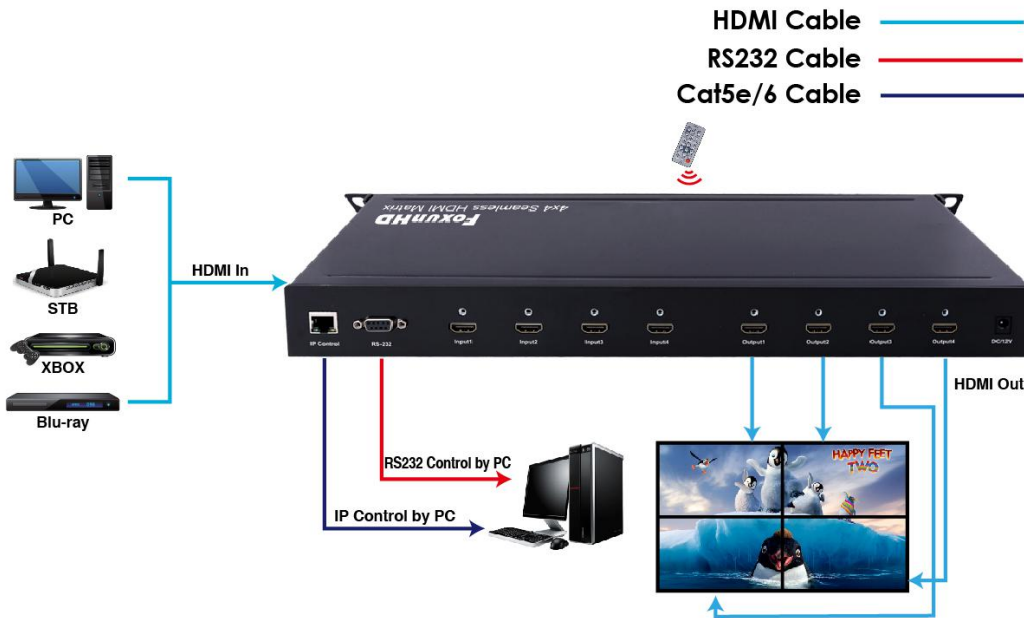

1. Control via remote

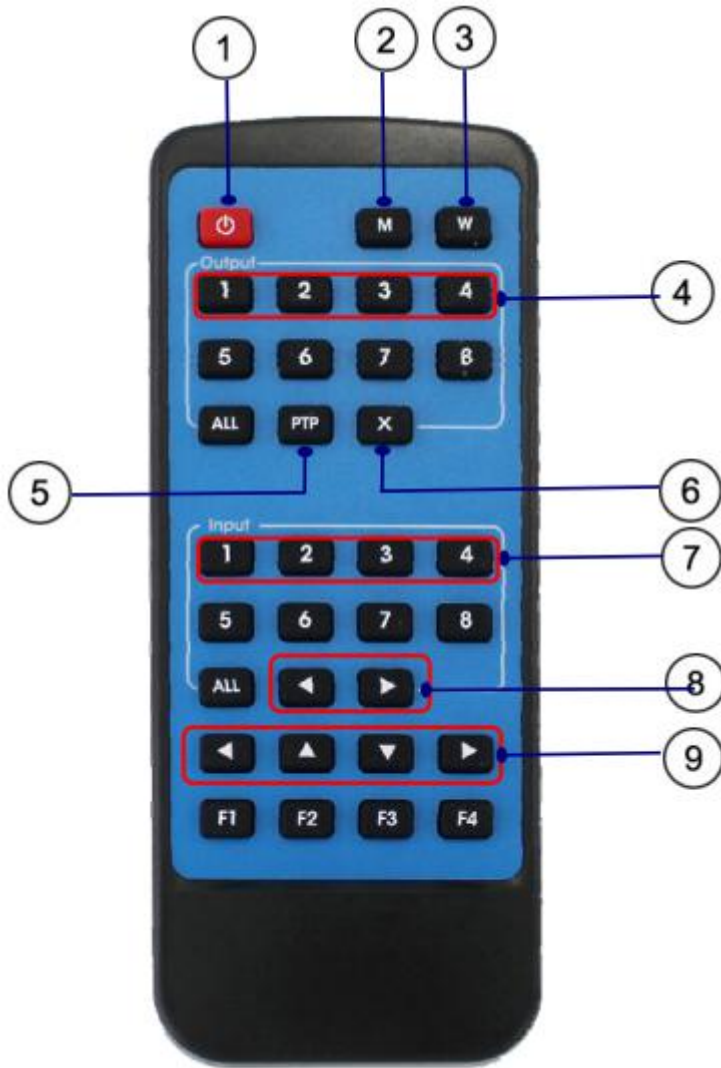

- ① Power on / off
- ② Matrix mode button
- ③ Video wall mode button
- ④ Output button: Output 1/Output 2/Output 4
- ⑤ PTP button:
- ⑥ Output 1 display input 1, Output 2display input 2, Output 3 display input 3, Output 4 display input 4,
- ⑦ Input button: Input 1/Input 2/Input 3/Input 4
- ⑧ Select the input sources under video

wall mode

- ⑨ Boarder setting under video wall mode

2. Control via RS232

1) switch setting

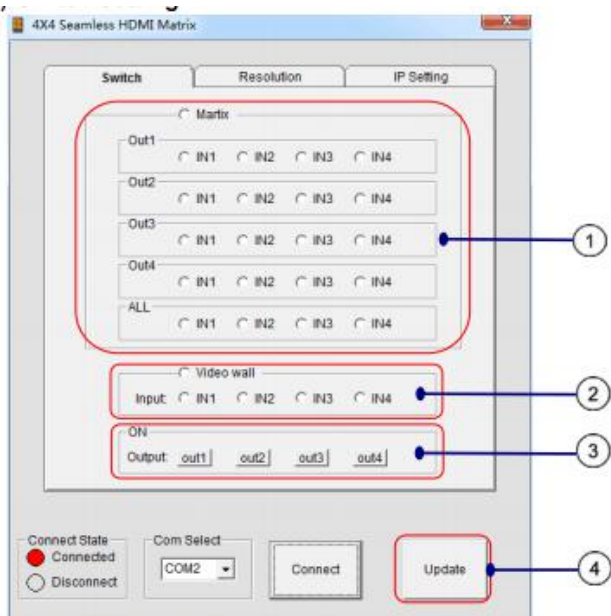



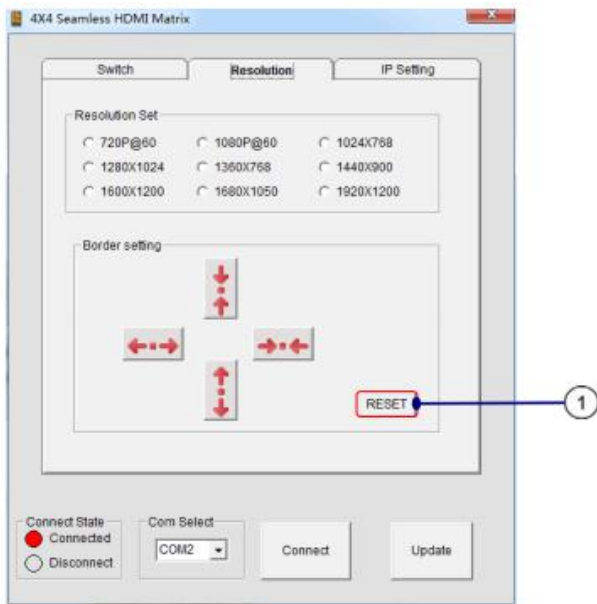

- ① Matrix mode: select the input port for output 1~4
- ② Video wall mode:all the four output will show the different part of the same input source.
- ③ ON: Factory defaults setting is all output is on, the button is green. Click”out1,out2,out3,out4,it will turn off, the button will turn red
- ④ Update:update the working status of FX-SMX44

2) Resolution and border setting



Border setting is only effective when working in video wall mode

① Reset: Click "RESET" to reset to default border setting.

-  the border line will decrease in vertical direction
-  the border line will increase in vertical direction
-  the border line will decrease in horizontal direction
-  the border line will increase in horizontal direction

3) IP setting

Click OK button to set IP address for LAN control (for example: 192.168.1.111)



4) Control command format

If user want to write his own control software,below are data format and baud rate setting

Com port setting:

Baud Rate:	9600 bps
Data bits:	8 bits
Parity:	None
Stop bits:	1 bit
Flow control:	None

5) RS232 command

send (hex)					feedback (hex)					description
length	start	index	parameters	END						
0x05	0x55	0x19	0x00	0x77	0x73	0x31	0x30	0x0D	0x0A	OUTPUT1->INPUT1
			0x01	0x77		0x31	0x31			OUTPUT1->INPUT2
			0x02	0x77		0x31	0x32			OUTPUT1->INPUT3
			0x03	0x77		0x31	0x33			OUTPUT1->INPUT4
			0x10	0x77		0x32	0x30			OUTPUT2->INPUT1
			0x11	0x77		0x32	0x31			OUTPUT2->INPUT2
			0x12	0x77		0x32	0x32			OUTPUT2->INPUT3
			0x13	0x77		0x32	0x33			OUTPUT2->INPUT4
			0x20	0x77		0x33	0x30			OUTPUT3->INPUT1
			0x21	0x77		0x33	0x31			OUTPUT3->INPUT2
			0x22	0x77		0x33	0x32			OUTPUT3->INPUT3
			0x23	0x77		0x33	0x33			OUTPUT3->INPUT4
			0x30	0x77		0x34	0x30			OUTPUT4->INPUT1
			0x31	0x77		0x34	0x31			OUTPUT4->INPUT2
			0x32	0x77		0x34	0x32			OUTPUT4->INPUT3
			0x33	0x77		0x34	0x33			OUTPUT4->INPUT4
0x05	0x55	0x02	0x00~0x03	0x77					power on/off output video	
0x05	0x55	0x21	0x00~0x01	0x77	0x4D	0x44	0x30~0x3	0x0D	0x0A	0:matrix mode 1:video wall mode
0x05	0x55	0x23	0x00~0x03	0x77	0x4D	0x50	0x30~0x3	0x0D	0x0A	select input port when working in video wall mode
0x05	0x55	0x22	0x00~0x08	0x77	0x82	0x83	0x30~0x3	0x0D	0x0A	Resolution setting: 0:720P; 1:1080P; 2:1024X768; 3:1280X1024 4:1360X768 5:1440X900 6:1600X1200 7:1680X1050 8:1920X1200
0x04	0x55	0x02		0x77						status

6) Web password reset

The command length is 4 bytes

rpw+“↵”

“rpw”is the key word,“↵”is carriage return.

When you send the Web password reset command to FX-SMX44, if succeed,it will feedback “rpw”,and the web password will be set as “0000000000”

3. IP Control

Note: Use the RJ45 cable to connect with PC,or use RJ45 cable to connect to the Ethernet router.

1) Double click Netfinder.exe. Click”Search” button to get the device’s IP address

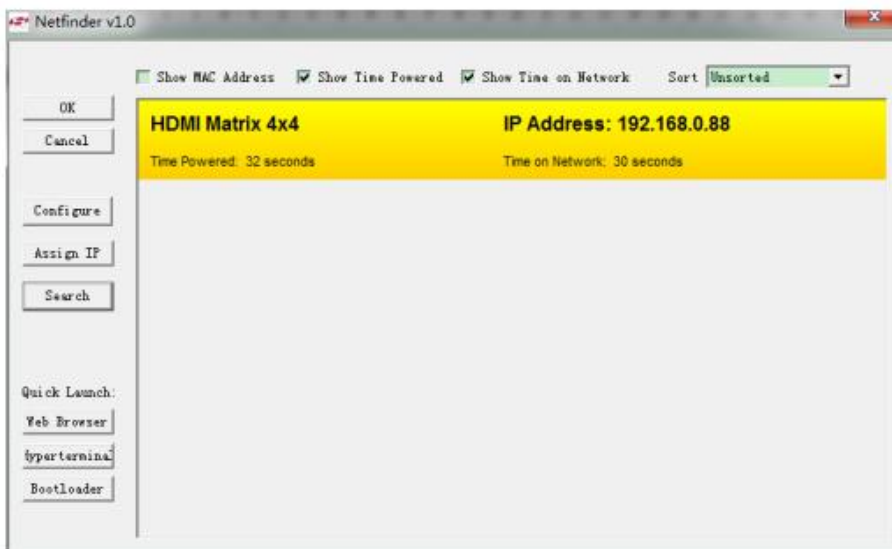

2) Click “Web Browser” button. A web browser will be shown.The default password is “0000000000”, input the password and login. The device controller page will be displayed.

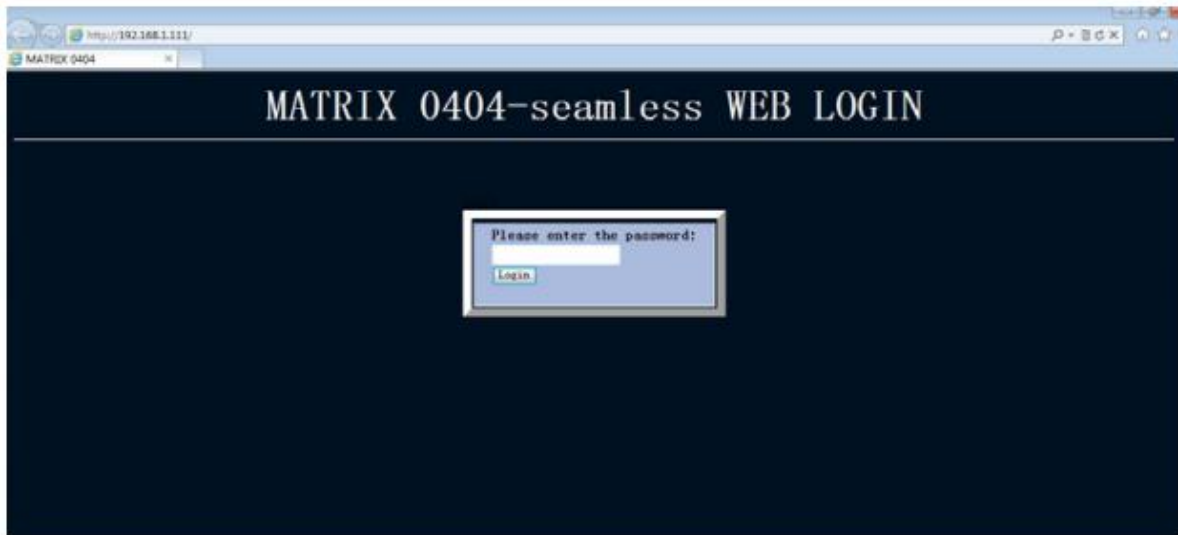

MAINTENANCE

Clean this unit with a soft, dry cloth. Never use alcohol, paint thinner or benzene to clean this unit.

PRODUCT SERVICE

1) **Damage requiring service:** The unit should be serviced by qualified service personnel if:

- (a) The DC power supply cord or AC adaptor has been damaged;
- (b) Objects or liquids have gotten into the unit;
- (c) The unit has been exposed to rain;
- (d) The unit does not operate normally or exhibits a marked change in performance;
- (e) The unit has been dropped or the cabinet damaged.

2) **Servicing Personnel:** Do not attempt to service the unit beyond that described in these operating instructions. Refer all other servicing to authorized servicing personnel.

- 3) **Replacement parts:** When parts need replacing ensure the servicer uses parts specified by the manufacturer or parts that have the same characteristics as the original parts. Unauthorized substitutes may result in fire, electric shock, or other hazards.
- 4) **Safety check:** After repairs or service, ask the servicer to perform safety checks to confirm that the unit is in proper working condition.

WARRANTY

If your product does not work properly because of a defect in materials or workmanship, our Company (referred to as "the warrantor") will , for the length of the period indicated as below,

(Parts(2)Year ,Labor(90) Days) which starts with the date of original purchase ("Limited Warranty period"), at its option either(a) repair your product with new or refurbished parts, or (b) replace it with a new of a refurbished product. The decision to repair or replace will be made by the warrantor.

During the "Labor" Limited Warranty period there will be no charge for labor.

During the "Parts" warranty period, there will be no charge for parts. You must mail-in your product during the warranty period. This Limited Warranty is extended only to the original purchaser and only covers product purchased as new. A purchase receipt or other proof of original purchase date is required for Limited Warranty service.

LIMITED WARRANTY LIMITS AND EXCLUSIONS

- 1) This Limited Warranty ONLY COVERS failures due to defects in materials or workmanship, and DOES NOT COVER normal wear and tear or cosmetic damage. The Limited Warranty ALSO DOES NOT COVER damages which occurred in shipment, or failures which are caused by products not supplied by warrantor,or failures which result from accidents,misuse,abuse,neglect, mishandling, misapplication, alteration, faulty installation, set-up adjustments, misadjustment of consumer controls, improper maintenance, power line surge, lightning damage, modification, or service by anyone other than a Factory Service center or other Authorized Servicer, or damage that is attributable to acts of God.
- 2) THERE ARE NO EXPRESS WARRANTIES EXCEPT AS LISTED UNDER "LIMITED WARRANTY COVERAGE".THE WARRANTOR IS NOT LIABLE FOR INCIDENTAL OR CONSEQUENTIAL DAMAGES RESULTING FROM THE USE OF THIS PRODUCT, OR ARISING OUT OF ANY BREACH OF THIS WARRANTY. (As examples, this excludes damages for lost time, cost of having someone remove or

re-install an installed unit if applicable, travel to and from the service, loss of or damage to media or images, data or other recorded content. The items listed are not exclusive, but are for illustration only.

PARTS AND SERVICE, WHICH ARE NOT COVERED BY THIS LIMITED WARRANTY, ARE YOUR RESPONSIBILITY.